

Owners Manual

Installation - Operation - Maintenance



Electric Counter Top Ovens

350 series

PM 351ED – PM 351ED-1 – PM 352ED – PM 352ED-1 – PM 352ED-2

PM 351ED-DW - PM 351ED-1DW - PM 352ED-DW - PM 352ED-1DW - PM 352ED-2DW

400 series

PM 401ED – PM 401ED-1 – PM 402ED – PM 402ED-1 – PM 402ED-2

PM 401ED-DW - PM 401ED-1DW - PM 402ED-DW - PM 402ED-1DW - PM 402ED-2DW

450 series

PM 451ED – PM 451ED-1 – PM 452ED – PM 452ED-1 – PM 452ED-2

PM 451ED-DW - PM 451ED-1DW - PM 452ED-DW - PM 452ED-1DW - PM 452ED-2DW

550 series

PM 551ED – PM 551ED-1 – PM 552ED – PM 552ED-1 – PM 552ED-2

APPROVALS *approvals vary depending on market*

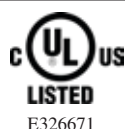

PizzaMaster®

PizzaMaster® ovens are designed and built by Svenska BakePartner AB

We thank you for your trust and congratulate you on the purchase of your new PizzaMaster® oven. Our goal has always been to build the best pizza ovens in the world. Right from the start, we knew this could be achieved only by specializing in the pizza industry and making bake-quality our top priority. PizzaMaster® ovens are therefore made exclusively for the pizza industry to meet the demands of all businesses that depend on quality pizza.

2-year manufacturer's warranty

All PizzaMaster® Counter Top ovens come with a 2-year limited warranty that covers the purchaser against any defect in material or workmanship. For further details about this important cover, please consult your BakePartner representative.

Special expertise

PizzaMaster® service technicians are trained specialists. They are equipped with all instruments and tools needed to make the correct diagnosis and perform service work quickly and efficiently. Our technicians travel the world continuously, training local technicians to uphold the BakePartner standard.

Genuine parts

Your PizzaMaster® oven consists of over 1000 quality parts with long service life. Should it become necessary to replace a part, it is most important to replace it with a genuine PizzaMaster® part. This ensures not only optimum function but also continued safety in the workplace.

BakePartner™ Made in Sweden Svenska BakePartner AB Odegardsgatan 5 504 64, Borås Sweden Phone: +4633 230 025 info@bakepartner.com www.bakepartner.com www.pizzamaster.com	Model - Type	Serial No.		
	PM Oven Model	X0000 - 00X00		
	Power Supply	IP		
		00		
	Power Oven (kW)			
	X200	X100	X200	Total kW
	X100	00,0	00,0	000,0

Your PizzaMaster® oven

When contacting your local PizzaMaster® distributor or BakePartner direct for assistance, remember to quote the model designation and serial number of your oven, a copy of the power rating plate is placed above on the original owners manual that follows each oven delivered from our factory. This help us to help you more quickly.

Look for the PizzaMaster® original parts logo when ordering replacement parts



PizzaMaster® Stone Hearth Deck Ovens are manufactured by Svenska BakePartner AB

Customer Support: Tel: +46 33 230-025 | E-mail: info@bakepartner.com

Website: www.pizzamaster.com or www.bakepartner.com | HQ: Svenska BakePartner AB, Odegardsgatan 5, SE 504 64 Borås Sweden

Index	
Warranty and service.....	2
Index.....	3
Safety and Warnings	4
Installation	5
Electrical connection	6
Oven operation	9
First-time start-up	13
Steam System	14
Pizza Recipe / Oven Settings / Baking Guidelines	16
Maintenance and Preventative Maintenance	18
Changing of oven lamp and door gasket.....	21
Trouble shooting	22
Technical data.....	23
EU-Declaration of conformity.....	25
Notes	26

Attachment :

Electrical diagram

Safety Precautions and Warnings



To ensure safe operation, read the following manual that contains safety precautions and warnings for your own safety



High Risk of Electrocutation!

Disconnect appliance from power supply before opening.

To reduce the risk of electric shock, DO NOT remove or open electrical cover. Refer servicing to qualified personnel.



This appliances is not intended for use by persons (including children) with reduced physical, sensory or mental capabilities, or lack of experience and knowledge, unless they have been given supervisory or instruction concerning use of the appliance by a person responsible for their safety.

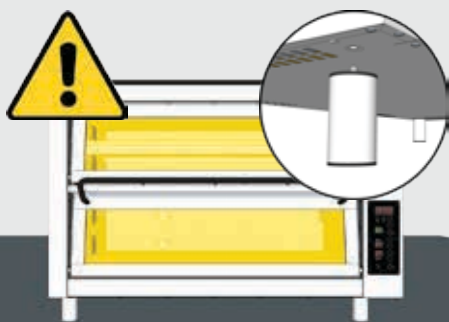

When positioning your oven, it is important to consider the following points:

It is important for the floor to be flat, so that the oven is both horizontal and stable.

You **MUST** install the legs enclosed with this appliance

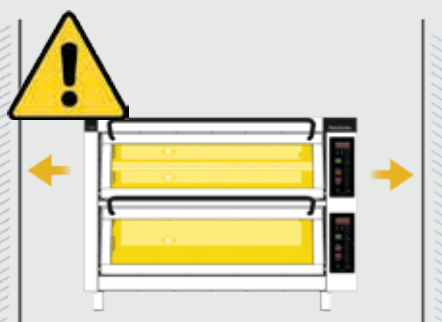

For ventilation of the oven, a space of at least 50 mm is needed between the oven and any adjacent wall, on all sides.

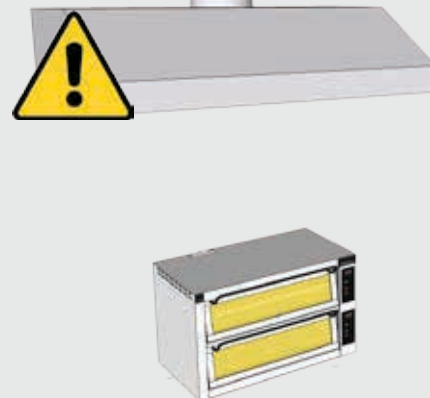

The oven needs to be placed under a ventilation hood or connected to a local ventilation system as per local code and regulations

Installation



1. The oven is packed safely and for easy transportation. Do not drop it or allow hard knocks. Cut the packing bands and remove the top and side cardboards



2. DO NOT carry the oven by the door handle



3. Remove the legs and owners manual from inside of the oven chamber

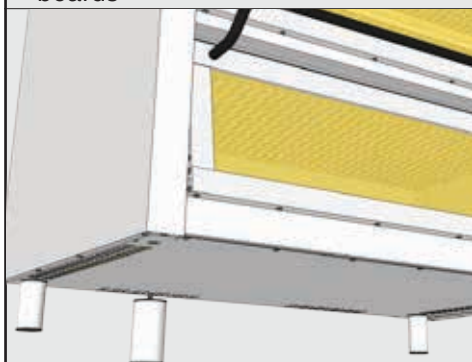

4. Lift the oven carefully and place the legs by screwing them to the bottom. You MUST install the legs enclosed with this appliance

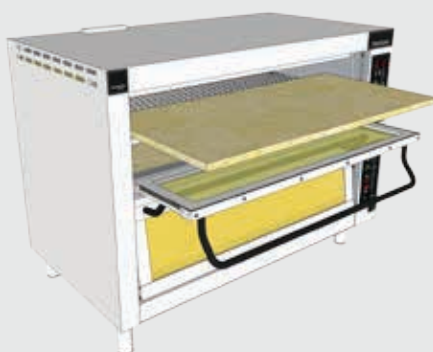

5. If your oven is equipped with 2 stones per chamber, carefully remove the stone placed in the bottom and place it over the middle part of the chamber



6. If possible, position the oven with easy access to the right hand panel to facilitate the electrical installation and future services

Accessories



Security Support Counter Top:

You must secure your oven with the Support through the two Security Support Holders in each side

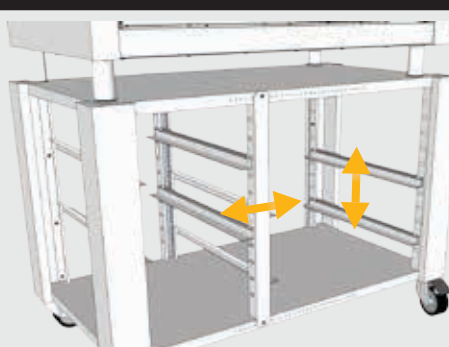

Shelf Support System

Place the Shelf Support System with the height and width most suitable for your needs or trays size

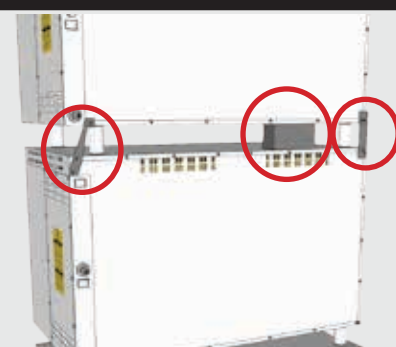

Ventilation Conduit

You can place one Counter Top oven over other; for this you must install the Ventilation Conduit between the two ovens and the ovens secure system holders

Electrical connection

Electrical connection

For connection and correct fuse rating, see the oven rating plate, the table for fuse protection need and the attached electrical diagram.

After reading **all** above information, follow instructions below for correct electrical connection.

The earth potential equalizer screw has to be installed.

The earth potential equalizer screw is located on the backside next to the connecting cable.

Important!

For reasons of safety and the validity of the warranty, all electrical work must be carried out by a qualified electrician.

The oven must be connected via an external main switch with min. 3 mm gape of at least 3 mm for each power supply cable.

Electrical Connection

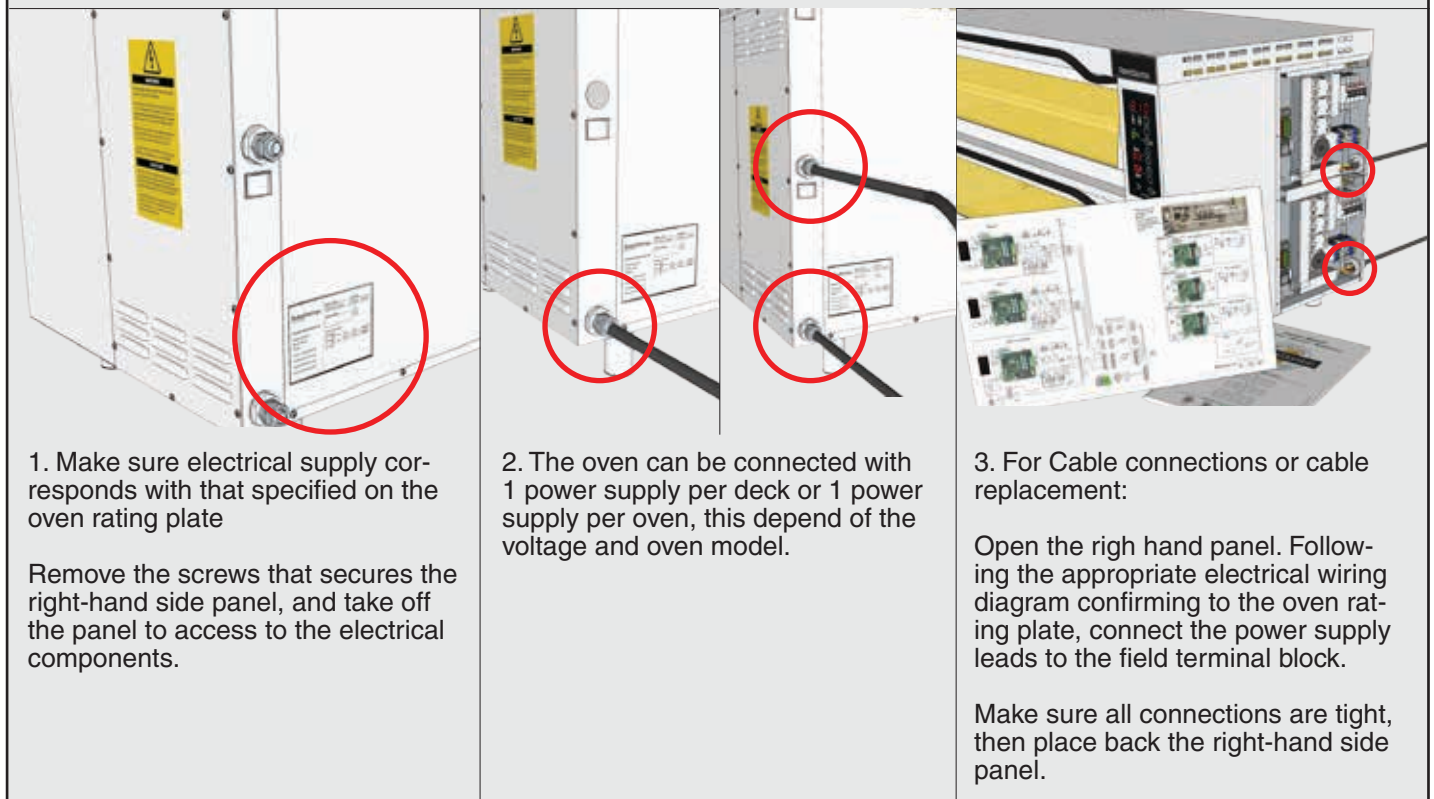

1. Make sure electrical supply corresponds with that specified on the oven rating plate

Remove the screws that secures the right-hand side panel, and take off the panel to access to the electrical components.

2. The oven can be connected with 1 power supply per deck or 1 power supply per oven, this depend of the voltage and oven model.

3. For Cable connections or cable replacement:

Open the right hand panel. Following the appropriate electrical wiring diagram confirming to the oven rating plate, connect the power supply leads to the field terminal block.

Make sure all connections are tight, then place back the right-hand side panel.

CounterTop series - Standard width

AMPS per phase and per OVEN

Model	230V 1ph + N	400V 3ph + N	480V 3ph + N	230V 3ph / 400V 3ph + N		200V 3ph	208V 1ph	208V 3ph	240V 1ph	240V 3ph	400V 3ph	460V 3ph (440-480)
				230V 3ph	400V 3ph + N							
PM 351ED	9.9	5.1	4.3	8.6	5.1	9.1	11.0	9.5	10.3	9.0	4.9	4.3
PM 351ED-1	14.7	5.1	4.3	8.6	5.1	9.1	16.3	9.5	15.3	9.0	4.9	4.3
PM 352ED	19.8	10.3	8.5	13.0	10.3	13.9	21.9	14.4	20.7	13.6	7.5	6.5
PM 352ED-1	24.6	10.3	8.5	17.2	10.3	18.3	27.2	19.0	25.7	17.9	9.9	8.6
PM 352ED-2	29.4	10.3	8.5	17.2	10.3	18.3	32.3	19.0	30.7	17.9	9.9	8.6
PM 401ED	13.4	6.9	5.7	11.6	6.9	12.7	14.8	12.8	14.0	12.4	6.8	5.9
PM 401ED-1	19.9	6.9	5.7	11.6	6.9	12.7	22.0	12.8	20.8	12.4	6.8	5.9
PM 402ED	26.8	13.7	11.4	17.6	13.7	18.7	29.6	19.4	27.9	18.3	10.1	8.8
PM 402ED-1	33.3	13.7	11.4	23.2	13.7	24.7	36.8	25.6	34.8	24.2	13.3	11.6
PM 402ED-2	39.8	13.7	11.4	23.2	13.7	24.7	-	25.6	-	24.2	13.3	11.6
PM 451ED	15.9	8.1	6.8	13.8	8.1	14.7	17.6	15.2	16.6	14.4	7.9	6.9
PM 451ED-1	23.7	8.1	6.8	13.8	8.1	14.7	26.2	15.2	24.7	14.4	7.9	6.9
PM 452ED	31.8	16.3	13.5	20.8	16.3	22.1	35.2	23.0	33.2	21.7	12.0	10.4
PM 452ED-1	39.6	16.3	13.5	27.6	16.3	29.3	-	30.5	-	28.8	15.8	13.8
PM 452ED-2	-	16.3	13.5	27.6	16.3	29.3	-	30.5	-	28.8	15.8	13.8
PM 551ED	19.3	9.8	8.2	16.7	9.8	17.8	21.3	18.5	20.1	17.4	9.6	8.4
PM 551ED-1	28.8	9.8	8.2	16.7	9.8	17.8	31.8	18.5	30.0	17.4	9.6	8.4
PM 552ED	38.6	19.7	16.3	25.2	19.7	26.8	-	27.9	-	26.3	14.5	12.6
PM 552ED-1	-	19.7	16.3	33.4	19.7	35.5	-	37.0	-	34.9	19.2	16.7
PM 552ED-2	-	19.7	16.3	33.4	19.7	35.5	-	37.0	-	34.9	19.2	16.7

CounterTop series - Double width

AMPS per phase and per **OVEN** (models with 2 numbers require 2 separate electrical supplies)

Model	230V 1ph + N	400V 3ph + N	480V 3ph + N	230V 3ph / 400V 3ph + N		208V 1ph	208V 3ph	240V 1ph	240V 3ph	400V 3ph	460V 3ph (440-480)
				230V 3ph	400V 3ph + N						
PM 351ED-DW	19.5	9.6	7.9	12.7	9.6	21.6	14.1	20.3	13.3	7.3	6.4
PM 351ED-1DW	29.0	9.9	8.2	16.9	9.9	32.1	18.7	30.3	17.6	9.7	8.4
PM 352ED-DW	19.8 + 19.1	14.3	11.9	13.0 + 12.4	14.3	21.9 + 21.2	14.4 + 13.7	20.7 + 20.0	13.6 + 13.0	14.3	12.4
PM 352ED-1DW	19.8 + 28.7	19.1	15.9	13.0 + 16.6	19.1	21.9 + 31.7	14.4 + 18.3	20.7 + 29.9	13.6 + 17.3	17.0	14.8
PM 352ED-2DW	29.4 + 28.7	19.8	16.5	17.2 + 16.6	19.8	32.5 + 31.7	19.0 + 18.3	30.7 + 29.9	17.9 + 17.3	19.4	16.9
PM 401ED-DW	26.4	13.0	10.8	17.2	13.0	29.2	19.1	27.6	18.0	9.9	8.6
PM 401ED-1DW	39.5	13.4	11.1	22.9	13.4	-	25.3	-	23.9	13.2	11.4
PM 402ED-DW	26.8 + 26.1	19.6	16.2	17.5 + 16.9	19.6	29.6 + 28.8	19.4 + 18.7	27.9 + 27.2	18.3 + 17.7	19.5	16.9
PM 402ED-1DW	26.8 + 39.1	26.1	21.7	17.5 + 22.6	26.1	-	19.4 + 25.0	-	18.3 + 23.6	23.1	20.1
PM 402ED-2DW	39.8 + 39.1	26.8	22.2	23.2 + 22.6	26.8	-	25.6 + 25.0	-	24.2 + 23.6	26.3	22.9
PM 451ED-DW	31.5	15.6	12.9	20.5	15.6	34.8	22.7	32.8	21.4	11.8	10.3
PM 451ED-1DW	-	15.9	13.2	27.3	15.9	-	30.1	-	28.4	15.7	13.6
PM 452ED-DW	31.8 + 31.1	23.3	19.4	20.8 + 20.2	23.3	35.2	23.0 + 22.4	33.2 + 32.5	21.7 + 21.1	23.3	20.1
PM 452ED-1DW	-	31.1	25.8	20.8 + 27.0	31.1	-	23.0 + 29.8	-	21.7 + 28.1	27.5	23.9
PM 452ED-2DW	-	31.8	26.4	27.6 + 27.0	31.8	-	30.5 + 29.8	-	28.8 + 28.1	31.3	27.3

Digital Control Panel

Target Temperature

Power Light

Turbo Light

Timer Indicator

Service Light

UBC switch
(option)

7-day clock timer
(option)

Model

Serial Number

Power Supply

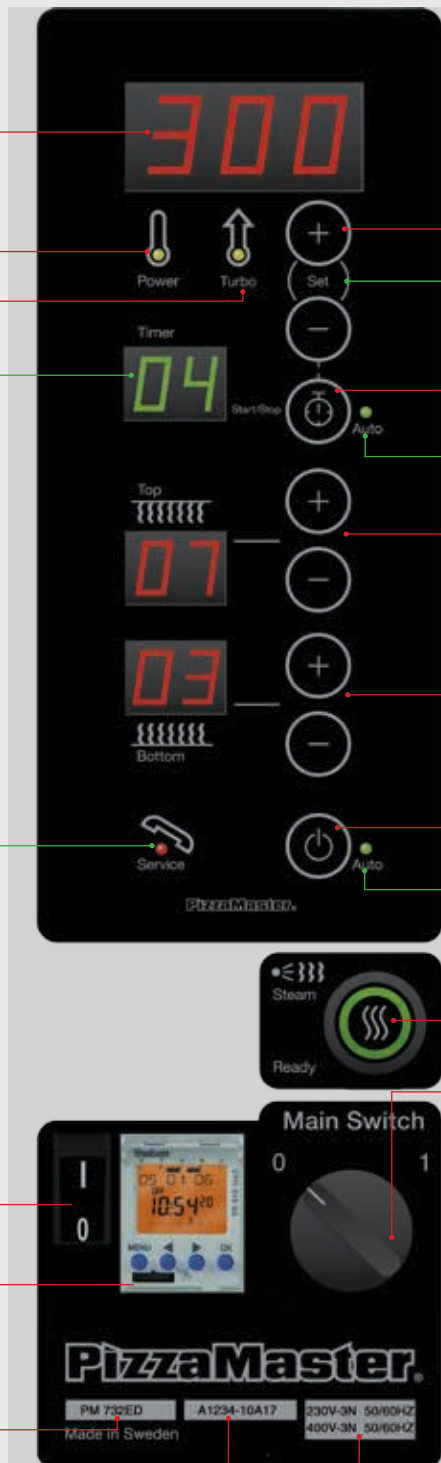

+ Adjust Target Temperature
- Adjust Target Temperature

(Set) Display Real Time Temperature

Timer Button

Timer Auto Mode When Lit

+ Adjust Top Heat Intensity from 0 to 10
- Adjust Top Heat Intensity from 0 to 10

+ Adjust Bottom Heat Intensity from 0 to 10
- Adjust Bottom Heat Intensity from 0 to 10

Turn Deck ON/OFF

Auto Light (7 days Timer Option)

Steam System (Option) – Ready to use when lit

MAIN SWITCH:
Turn Oven ON/OFF

0= Off
1= ON

Main Breaker
(Back right side)



Power : A yellow lamp indicates that the heating element is on.

Turbo: The turbo-start function, engaged automatically at start up, brings the oven up to temperature very quickly. When the desired temperature has been reached, the turbo-start shuts off automatically. A yellow lamp indicates that the turbo is in operation.

Service: If the oven overheats, it is turned off automatically. A red light will show when the overheating cut-off has been activated. The oven can be reset by turning off the main switch and turn it on again, when the temperature have gone down below 390 °C / 734 °F (for standard model), 490 °C / 914 °F (for high temperature model).

Operation Guide



Every deck has an independent Control Panel.

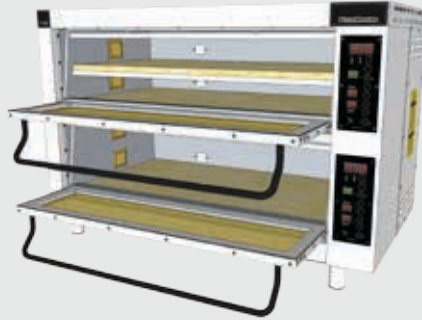

Two Stones per deck
Ovens with 2 stones per deck, has only one (1) Control panel for the whole deck.

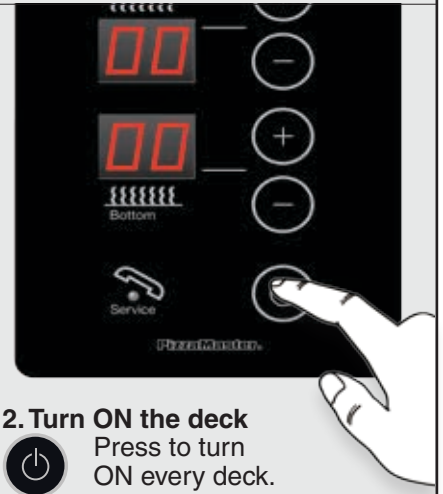

2. Turn ON the deck
Press to turn ON every deck.



3. Set Temperature
Press to adjust the desired temperature.

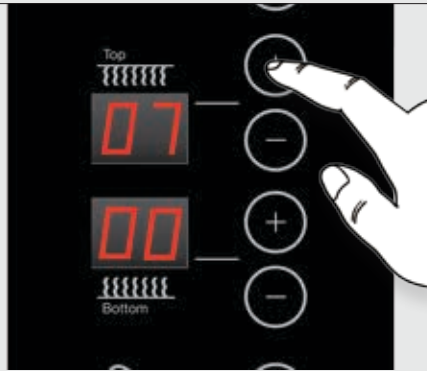

4. Set Top Heat Zone
Press to adjust the TOP heat intensity:
0 = Off / 10 = Maximum

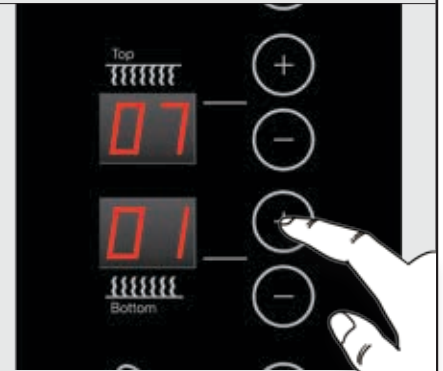

5. Set Bottom Heat Zone
Press to adjust the BOTTOM heat intensity:
0 = Off / 10 = Maximum



6. Real Time Temperature
Press and hold SET button to display the deck actual temperature at any time

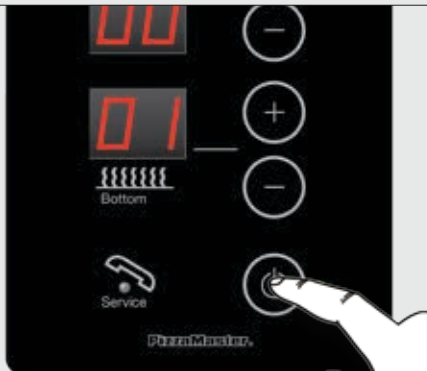

7. Turn "OFF" the deck
Press to turn OFF the deck.



You can Turn Off one of the decks on the low work hours

Individual Baking Times - Normal Mode

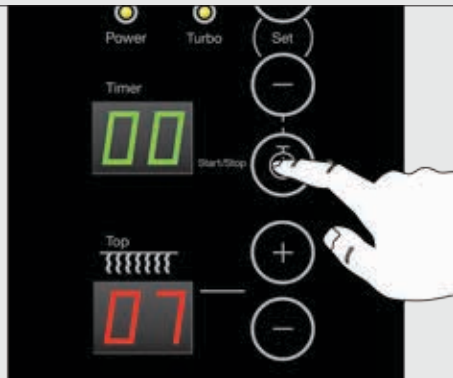

1. Turn ON Timer
Press Timer button



2. Set Time
Press to adjust the desire baking time (minutes)

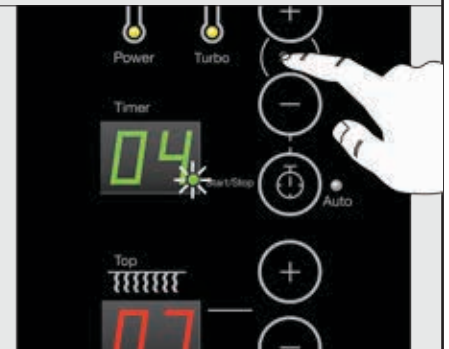

3. Confirm
Press SET button to confirm. A green indication light is turned on in the timers display

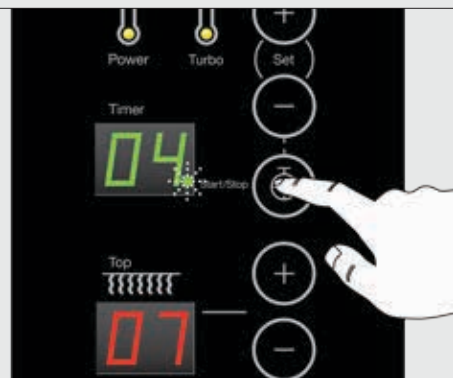

4. Start Timer
Press Timer button to START timer. The green light is flashing and remaining time is showed



5. PAUSE / STOP
Press Timer to PAUSE time. Press Timer and SET to STOP

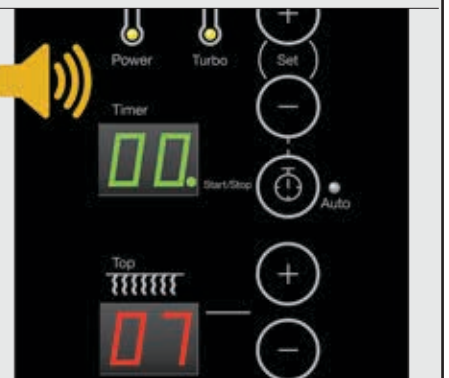

6. Alarm
An alarm comes on when the time has passed, count down comes to 0 (zero)



7. Shutting Off the Alarm
Press Timer button to Shut off the alarm

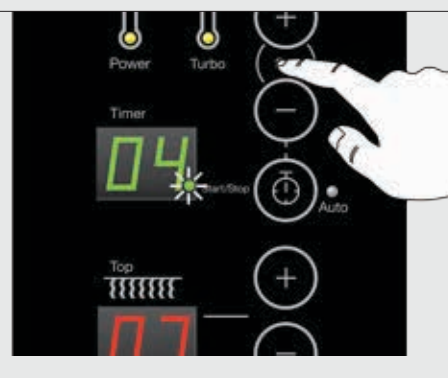

8. Finish
Press SET button to finish. The green indication light is turned on in the timers display

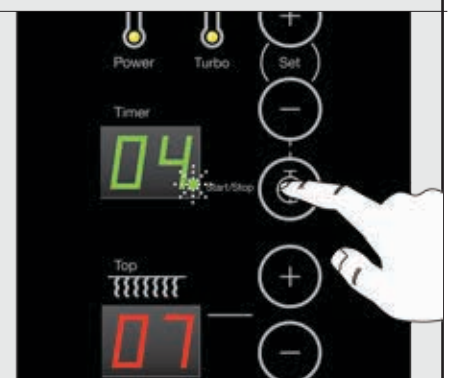

9. Repeat the cycle
Press Timer button to repeat the cycle. The green indication light will flash



Common Baking Time - Auto Mode

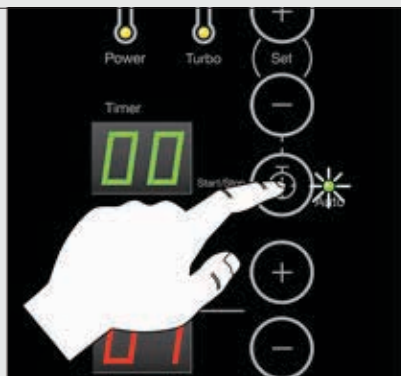

1. Turn ON timer



Press and hold Timer button until the green Auto lamp is turned On



2. Set Time



Press to adjust the desired baking time (minutes)



3. Confirm



Press SET button to confirm. A green indication light is turned on in the timers display



4. Start Timer



Press Timer button to START timer. The green light will flash



5. Five (5) independent Alarms



Up to 5 independent alarms can be activated. Press Timer button for each one of them



6. Alarm

After desired baking time, the oven gives a 3 second alarm for every preset time



6. New Alarm



You can add a new alarm as soon as another alarm has finished, press Timer to set the new time

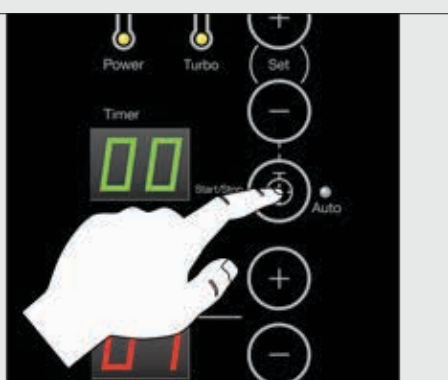

7. Turn "OFF" Timer



Hold Timer until the light goes off, and press SET to turn OFF the timer

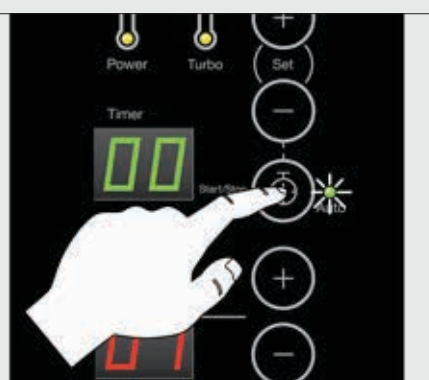

8. Repeat



To replay, press and hold Timer button until the green Auto lamp is Turned On

First-time start-up of oven



1. Before putting the oven into operation, it should be switched on and brought up to temperature to burn off any remaining protective oil in the oven chamber(s). During this operation the oven will emit a certain amount of smoke, which is normal.

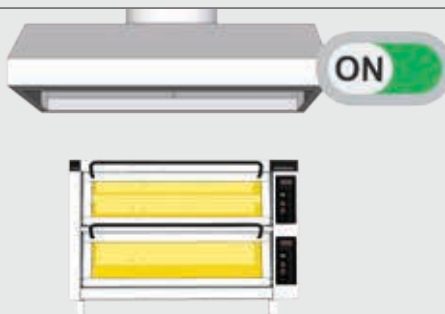

2. Make sure therefore that the kitchen ventilation system is switched on. If possible, open doors and windows to allow the smoke to escape more quickly. All decks can be switched on simultaneously



3. Turn ON every Oven Deck



Press ON/OFF button in every deck to turn them ON.



5. Set Temperature in 350°C (662°F)



Press the buttons to set the oven 350°C (662°F)

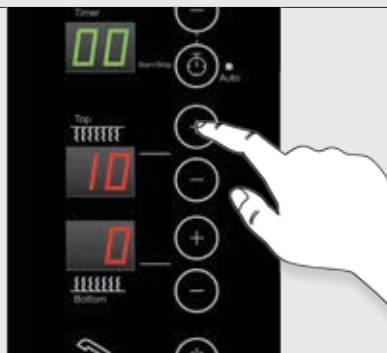

6. Set Top Heat Zone



Press the button to adjust the Top Heat intensity to 10 in every deck.



7. Set Bottom Heat Zone



Press the button to adjust the Bottom Heat intensity: to 10 in every deck.

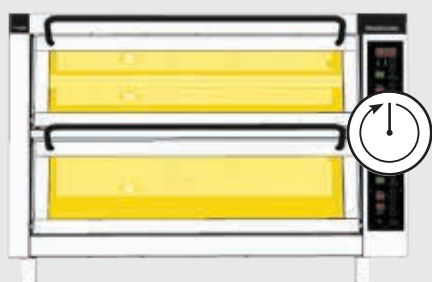

4. When the oven reaches 300 C (which takes about 20 minutes), leave it switched on for 1 hour.



5. Let all the smoke go out from the oven.



Congratulations!

Now your oven is ready to use!

Steam System

Steam System Installation

Important!

- Particle filter must be installed on incoming water line.
- Water softener is recommended to install on incoming water line.

Important!

Guidelines for water quality:

- Magnesium, Mg (<30 mg/l)
- Calcium, Ca (20 – 100 mg/l)
- Hardness, dH (4,0 – 7,0 dH)
- pH at 20°C (7,5 – 8,5 pH)
- Alkalinity, HCO₃ (>60 mg/l)

Steam System Installation



Your oven can be equipped with an optional Steam System in 1 or more decks

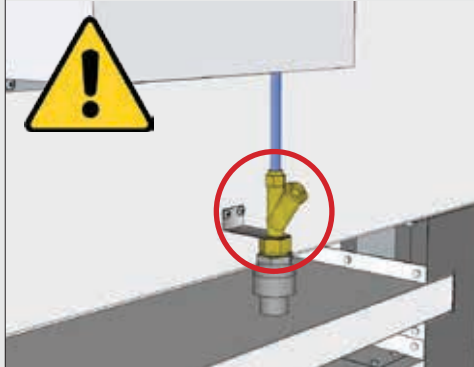

This appliance must be installed with a proper backflow protection system by an authorized personnel



Incoming water pressure must not exceed 6.0 bar (0,6 MPA)



If incoming water pressure is above 6.0 bar (0.6 MPA) a Water Pressure Reducing Valve must be installed

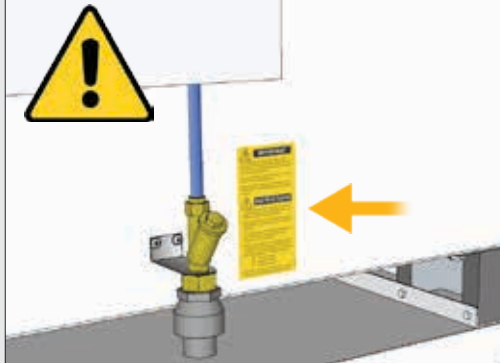

Read carefully the instructions on the label attached to the steam system

2. Make sure that the Blue Knobs are at the minimum position by turning the knob in (-) negative direction
3. Connect the hose and open the Air Relief Valve, turn on the water supply and let water flow through the valve and close it.
4. With the water supply open, set water pressure on all decks with the pressure marked below by gradually increasing the pressure by turning the Blue Knob regulator in (+) positive direction:
 - 1,4 bar (0,14 MPA)
 - 1,6 bar (0,16 MPA)
 - 1,8 bar (0,18 MPA)
5. Test Steam System 2 times per deck to assure that correct water pressure has been achieved

The label indicates the water pressure that the system needs to be adjusted to



1. Make sure that the Blue Knobs are at the minimum position by turning the knob in (-) negative direction



2. Open the water supply and let water run, this will clean the hose and any other residue in the water system before connecting the water supply to the Steam System

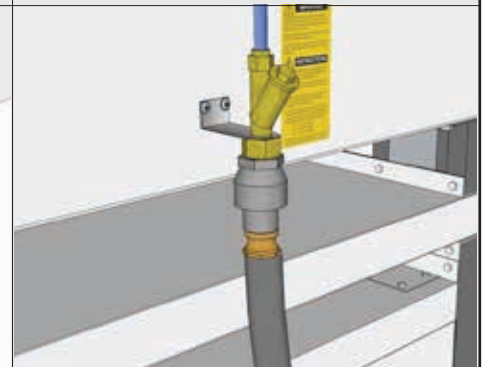

3. Connect the hose to the oven

Steam System Installation and Use



4. Open the Air Relief Valve

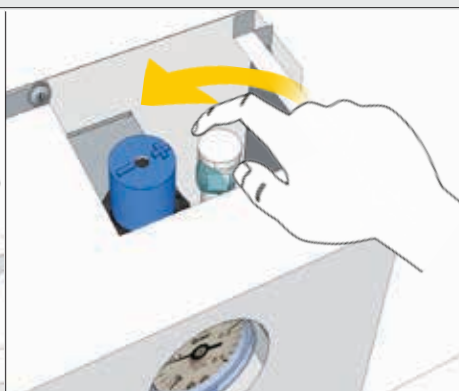

5. Turn ON the water and let water flow through the valve and then close the Air Relief Valve



6. Set the water to the pressure marked on the label by turning slowly the Blue Knob regulator in the (+) positive direction.
* Repeat for all decks



7. Turn ON the oven and set the temperature to 220 C (428 F). The Steam Button will light up to show that the system is ready (15 minutes after the oven has reached 200 C (392 F))

Press the Steam Button to produce steam inside the deck



8. The Steam System needs 12 minutes to reload.

Test the Steam System 2 times per deck to assure that correct water pressure has been achieved

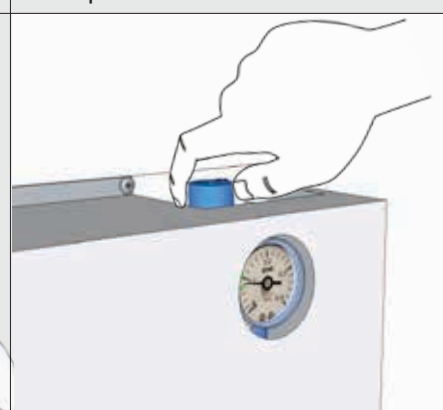

9. Adjust the Steam System if necessary

Use



1. At first start when the oven reach 200 C (392 F), the steam system takes 15 minutes to get ready



2. After the 15 minutes, the Steam Button lights as a signal that the system is ready to be use. Press and release the button at anytime



3. The button light turn off and waits 12 minutes to get ready one more time

Pizza Recipe / Oven Settings / Baking Guidelines

Pizza Recipe and Baking Temperature

Pizza Dough Recipe

Flour (*bakers % = 100)

Always use a high quality flour (double zero (00) preferably an Italian brand as quality is higher and more consistent)

Water (*bakers % = 65)

Salt (*bakers % = 3)

Yeast Fresh, (*bakers % = 1) or Dry (equivalent to fresh yeast as recommended by producer)

Required baking time (classic margarita pizza)

290 C / 554 F = 4min 10sec (change water to 50% change salt to 1.5%, add sugar with 1.5%, add oil with 3.5%)

310 C / 590 F = 3min 40sec (change water to 50% change salt to 1.5%, add sugar with 1.5%, add oil with 3.5%)

330 C / 626 F = 3min 20sec (change water to 55% change salt to 2%, add sugar with 1%, add oil with 3.5%)

350 C / 662 F = 2min 50sec (change water to 60% change salt to 2.5%, add sugar with 0.5%, add oil with 3.5%)

370 C / 698 F = 2min 30sec (baking at this temperature or higher we recommend our high temperature model)

400 C / 752 F = 2min 10sec

430 C / 806 F = 1min 50sec (at this temperature or higher the pizza "positively dry out" as most of the fluids vaporize)

460 C / 860 F = 90sec (5sec at this temperature or higher can make the difference between failure and success)

490 C / 914 F = 60sec

Oven Settings

Important!

- Never set the Top Heat lower than 3

Pizza baked direct on stone

Temperature	See above recipe	
Stones/door	1	2
Top	6-8	5-7
Bottom	0-3	2-4

Pizza baked in Pan or on Grid

Temperature	See above recipe	
Stones/door	1	2
Top	3-5	5-7
Bottom	6-10	2-4

Roast/Bake/Grill Food

Temperature	180-220 C (355-430 F)	
Stones/door	1	2
Top	5	5-7
Bottom	5	2-4

Bread

Temperature	Japanese/Asian bread 160-190 C (320-375 F) European bread 200-240 C (390-465 F)	
Stones/door	1	2
Top	4	not suitable
Bottom	6	not suitable

If you require further baking guidance contact your local PizzaMaster representative or PizzaMaster directly.

Dough Preparation

Important!

Use cold water (this is important for having a uniform result) if using room temperature water the fermentation process starts and you will have less control over the fermentation.

1. Put water into mixer and thereafter dissolve the yeast in water. Put in salt and 75% of the flour.
2. Mix on lowest speed for 3min (depending on mixer the time can vary, the dough should be completely blended).
3. Start the mixer again on slowest speed.
4. After 5min start to add the remaining flour gradually.
5. Increase speed after 8min.
6. Stop mixing after 15min and let the dough rest for 20min.
7. Take out the dough from the mixer and put it on a floured surface and cut into balls (for 33cm 310gr)
8. Place the dough balls in plastic boxes with airtight lids.
9. If the dough is wet it can be "sticky" put a little (very little) olive oil on the dough and your hands to make dough handling easier.
10. Store cold for 2-3 days (for the very best result reshape doughballs every 24 hours)

Making the Pizza

1. Take out the dough from the fridge 90min before baking
2. If having a very light or wet dough it can be easier to use a wooden peel and/or open the pizza directly on the peel.
3. For easier dough handling always use plastic tools when working with the dough.
4. Use as little flour as possible when "opening" the pizza dough and always shake off excess flour.

Recommendations

- Use only, for the tomato sauce, canned whole tomatoes of good quality, remove all hard parts from the tomatoes.
- Use buffalo mozzarella, dry the mozzarella as much as possible (tip is to put flaked sea salt on mozzarella 5-10min before use)
- Add extra virgin olive oil on pizza before putting it into oven for extra taste
- Do not use too much topping on pizza as this "kills" the dough
- Do not use wet toppings or topping with high water content on pizza as this can make the pizza soggy. Example is mushrooms or bell peppers, always roast similar toppings before so most of the water is removed.
- Topping can with benefit be placed on the pizza after taking it out from the oven.
- When taking the pizza out from the oven, place it on a grid or screen that is elevated at least 50mm/2in as this lets the pizza "ventilate" (pizza is still baking after it is removed from oven and if placing it on a flat surface it will condensate water and this will be sucked up into the crust making it soggy). Let the pizza rest like this for 1-2min.

Maintenance and Preventative Maintenance

Warning!

- DO NOT** use any cleaning agents on the hearthstones
- DO NOT** use pressure washing equipment or a water hose to clean the oven
- DO NOT** use abrasive materials like steel wool or abrasive sponges to clean the oven door glass or the under built cabinets glass doors
- DO NOT** clean the oven door glass until it's cool enough to touch
- DO NOT** use any oven cleaners or detergents to clean the aluminum coated steel interior
- DO NOT** clean the oven when it is hot to avoid burning injuries
- DO NOT** clean ovens in Phantom Black or Royal Gold exterior with any abrasive cleaners inclusive of PizzaMaster cleaning cloth for stainless steel surfaces

Preventive Maintenance

- DO** always install oven with required minimum clearance for easy maintenance
- DO** create a cleaning program and regularly clean the oven
- DO** routinely service the oven and only use original parts
- DO** contact your nearest PizzaMaster representative or PizzaMaster directly if maintenance or repairs are necessary

Important!

It is possible to use conventional non toxic oven cleaners but for the best possible cleaning result we always recommend PizzaMaster cleaning products

Environment friendly cleaning

PizzaMaster has developed a unique range of cleaning and maintenance products especially made for pizza and bakery ovens. Using these products saves the environment at the same time as they are much easier to use than conventional oven cleaning products and helps keep your oven new longer.

Product	Art. No	Suitable for
Oven brush Metal with scraper	50053-01	cleaning the ovens hearth stones from soot and baking deposits
Oven brush Soft	50053-02	cleaning the ovens hearth stones from soot and baking deposits
Cleaning cloth package	50341	removing burned soot from ovens stainless steel exterior no more need for oven cleaners when removing hard burned soot or deposits, this cloth cleans the ovens stainless steel exterior dry without the use of any water or cleaning fluids.
Cleaning sponge package	50716	regular exterior cleaning and cleaning oven door glass sponge with one side that is a regular sponge and the other side is a scratchy but non abrasive side that makes the daily cleaning very easy

To order these products contact your nearest PizzaMaster representative or PizzaMaster directly

Cleaning and Maintenance

Daily



1. Prepare Solution

Damp a nonabrasive sponge in a solution of dish liquid and water. Use a soft cloth to dry!



2. Clean Surfaces

Clean stainless Steel front exterior, door handles, display, glass and shelves. Dry with a soft cloth!



3. Clean Stone

Brush and scrape out bake deposit or soot regularly during the day. Use a metal and soft brush!

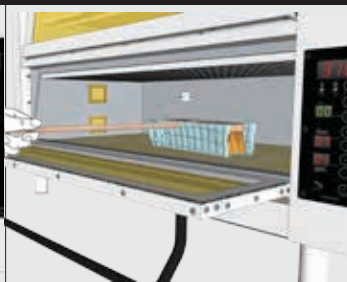

4. Brush Wrapped

It is possible to use a cloth lightly dampened with water and wrapped around the head of the brush.

Weekly

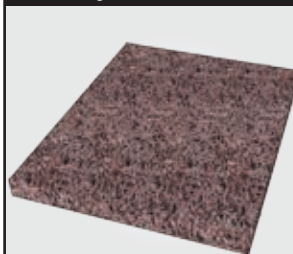

5. Use PizzaMaster Cleaning Cloth

PizzaMaster Cleaning cloth is special for stainless steel material.

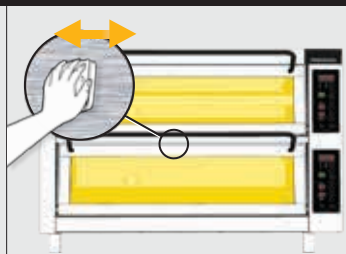

6. Clean Surfaces

Clean all the stainless steel surfaces with the cloth, always with grain direction. Do NOT use over glass, display, handles or labels!

Monthly



7. Lubricate

Lubricate all the door bushings.



8. Use High Temperature Lubricant

Use a non-toxic high temperature lubricant.

Yearly

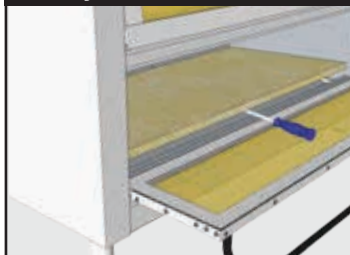

9. Clean Oven Chamber

Wait until the oven is completely cold and remove the stones; lift up the stones using a flat screwdriver.



10. Vacuum Oven Chamber

Vacuum the chamber and place back the stones exact in the same position and location.

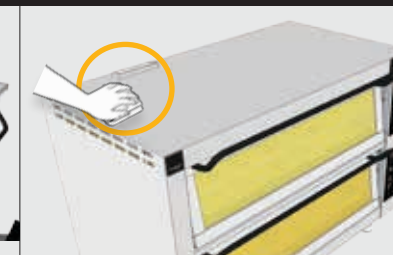

11. Ventilation Outlets

Clean soot and residues from the front and back top ventilation outlets.

Important

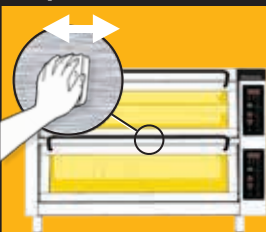

Always clean with grain direction!

Steam System Cleaning and Maintenance

Cleaning

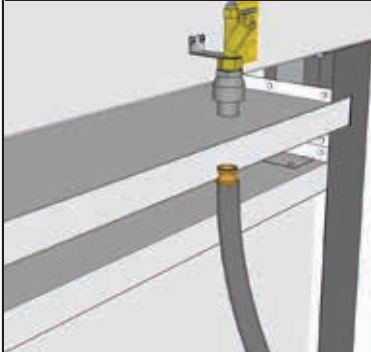

1. Turn off the water supply and disconnect the hose from the oven.

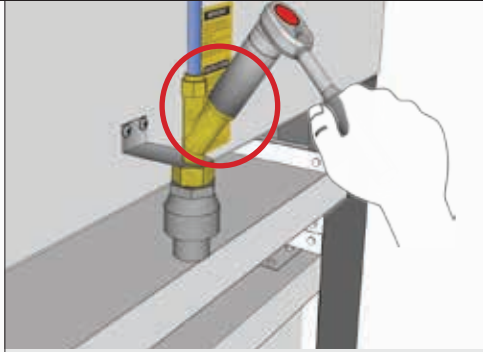

2. Open the filter on the back flow valve

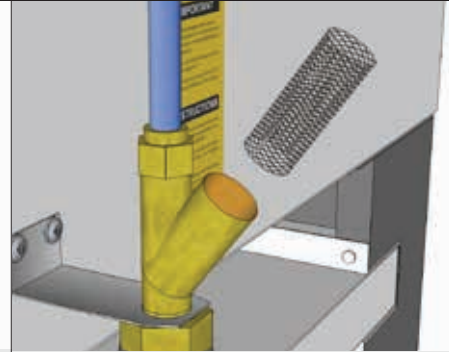

3. Take out the filter and clean it

Maintenance

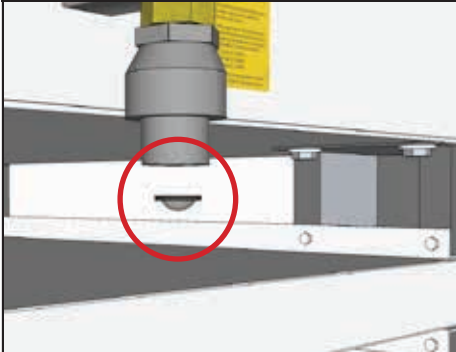

4. From the Water Block, take out the filter and clean it

*Repeat the "Installation steps" before using the Steam System

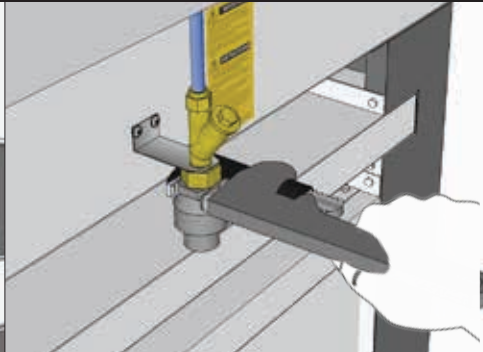

1. **RESET WATER BLOCK:**
If a failure occurs causing a continuous water leak, the Water Block will shut off.
Using a pipe wrench, remove the Water Block Safety valve

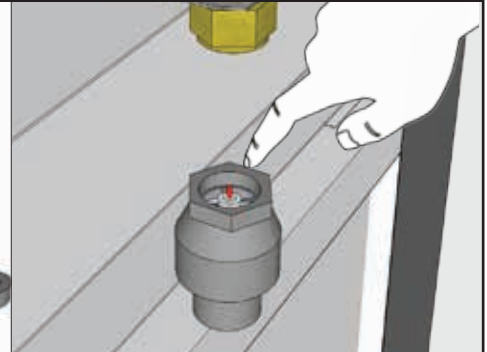

2. Press the red plunger to reset the Water Block

*Repeat the "Installation steps" before using the Steam System

Changing of oven lamp and door gasket

How to replace the oven lamps

Important!





Never touch the oven lamp with your fingers, this will result in severe shortage of the lamps lifetime, use gloves, a piece of paper or a piece of fabric to hold the lamp when replacing it.

Important!

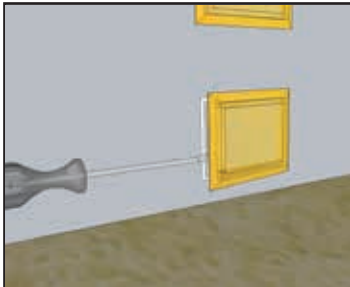

Never use other than original oven lamps supplied from your PizzaMaster representative or directly from PizzaMaster as this can damage the lamp transformer and the lamp socket.

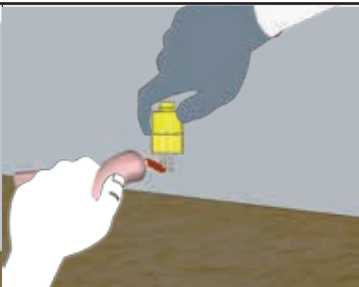
Warning!

Never try to change the oven lamp when the oven is hot, this can lead to severe burn injuries.

			
<p>Carefully remove the glass, you can use a flat screwdriver</p> <p>Hold the glass, do not allow the glass to fall on the stone</p>	<p>Take out the defective lamp. Make sure the old lamp has the 2 pin legs like the new lamp. If not part of the old lamp can still be left in the lamp socket, in this case it is necessary to replace also the lamp socket.</p>	<p>Place a small amount of copper paste on the new lamp pins make sure not to place any copper paste on the lamp bulb.</p> <p>Never touch the new lamp directly with your fingers!</p>	<p>Place the new lamp into the lamp socket. Never touch the new lamp directly with your fingers.</p> <p>Fit back the lamp glass.</p>

How to remove door gasket for cleaning or replacement

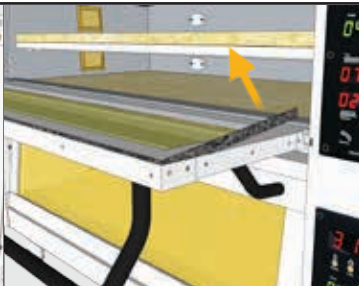
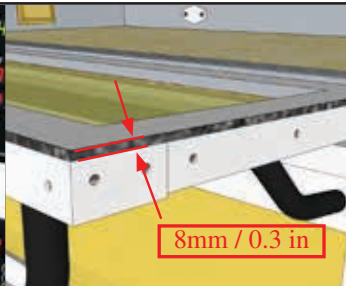
			
<p>Wait until the oven is at room temperature.</p> <p>Open the door.</p>	<p>For replacement of door gasket it is necessary to use a screwdriver with Phillips Head.</p> <p>Remove all screws, on both left right hand and top side of the oven door.</p>	<p>Remove the gasket.</p> <p>Make sure that the old gasket is fully removed.</p>	<p>Place the gasket in the gap between the door frame and the stainless steel parts. Make sure the gasket is left out with 8mm/0.3in.</p> <p>Fasten gasket and stainless steel parts by attaching all screws.</p>

Trouble shooting

Trouble shooting

The table below will help to make baking easier, simplify adjustments of the oven and help in the event of problem. If solution is not found please contact your nearest PizzaMaster® distributor or contact our service department.

SYMPTOM	POSSIBLE CAUSE	PROBABLE SOLUTION
The oven does not start	Main fuse has blown/tripped	Replace/reset main fuse
Oven temperature falls too much or recovery period is too long	Main fuse has blown/tripped	Replace/reset main fuse
	A power relay is broken	Replace power relay
	Top settings are too low	Increase settings for Top
The top of the pizza is too dark	Top settings are too high	Decrease settings for Top
	Too high baking temperature	Decrease baking temperature
The bottom of the pizza is too dark	Bottom is set too high	Decrease bottom
	Too high baking temperature	Decrease baking temperature
Both the top and bottom of the pizza is too dark	Too high baking temperature	Decrease baking temperature
	Too long baking time	Decrease baking time
Baking time is too long	Baking temperature is too low	Increase baking temperature



PizzaMaster® CounterTop series - Standard width

Model	Dimensions in millimetres Width x Depth x Height			Dimensions in inches Width x Depth x Height			Independent chambers per oven	Hearthstones per oven	Power kW
	External	Internal (per hearthstone)		External	Internal (per hearthstone)				
PM 351ED	595 x 545 x 500	355 x 355	x 195 (1 pcs)	23.4 x 21.5 x 19.7	14.0 x 14.0	x 7.7 (1 pcs)	1	1	2.25
PM 351ED-1			x 85 (2 pcs)			x 3.4 (2 pcs)			
PM 352ED			x 195 (2 pcs)			x 7.7 (2 pcs)			
PM 352ED-1	595 x 545 x 800	355 x 355	x 195 (1 pcs) 1)	23.4 x 21.5 x 31.5	14.0 x 14.0	x 7.7 (1 pcs) 1)	2	3	5.60
PM 352ED-2			x 85 (2 pcs)			x 3.4 (2 pcs)			
			x 85 (4 pcs)			x 3.4 (4 pcs)			
PM 401ED	650 x 600 x 500	410 x 410	x 195 (1 pcs)	25.6 x 23.6 x 19.7	16.1 x 16.1	x 7.7 (1 pcs)	1	1	3.05
PM 401ED-1			x 85 (2 pcs)			x 3.4 (2 pcs)			
PM 402ED			x 195 (2 pcs)			x 7.7 (2 pcs)			
PM 402ED-1	650 x 600 x 800	410 x 410	x 195 (1 pcs) 1)	25.6 x 23.6 x 31.5	16.1 x 16.1	x 7.7 (1 pcs) 1)	2	3	7.60
PM 402ED-2			x 85 (2 pcs)			x 3.4 (2 pcs)			
			x 85 (4 pcs)			x 3.4 (4 pcs)			
PM 451ED	700 x 650 x 500	460 x 460	x 195 (1 pcs)	27.6 x 25.6 x 19.7	18.1 x 18.1	x 7.7 (1 pcs)	1	1	3.63
PM 451ED-1			x 85 (2 pcs)			x 3.4 (2 pcs)			
PM 452ED			x 195 (2 pcs)			x 7.7 (2 pcs)			
PM 452ED-1	700 x 650 x 800	460 x 460	x 195 (1 pcs) 1)	27.6 x 25.6 x 31.5	18.1 x 18.1	x 7.7 (1 pcs) 1)	2	3	9.05
PM 452ED-2			x 85 (2 pcs)			x 3.4 (2 pcs)			
			x 85 (4 pcs)			x 3.4 (4 pcs)			
PM 551ED	775 x 725 x 500	535 x 535	x 195 (1 pcs)	30.5 x 28.5 x 19.7	21.1 x 21.1	x 7.7 (1 pcs)	1	1	4.41
PM 551ED-1			x 85 (2 pcs)			x 3.4 (2 pcs)			
PM 552ED			x 195 (2 pcs)			x 7.7 (2 pcs)			
PM 552ED-1	775 x 725 x 800	535 x 535	x 195 (1 pcs) 1)	30.5 x 28.5 x 31.5	21.1 x 21.1	x 7.7 (1 pcs) 1)	2	3	10.95
PM 552ED-2			x 85 (2 pcs)			x 3.4 (2 pcs)			
			x 85 (4 pcs)			x 7.7 (4 pcs)			



PizzaMaster® CounterTop series - Double width

Model	Dimensions in millimetres Width x Depth x Height			Dimensions in inches Width x Depth x Height			Independent chambers per oven	Hearthstones per oven	Power kW
	External	Internal (per hearthstone)		External	Internal (per hearthstone)				
PM 351ED-DW	950 x 545 x 500	710 x 355	x 195 (1 pcs)	37.4 x 21.5 x 19.7	28.0 x 14.0	x 7.7 (1 pcs)	1	1	4.45
PM 351ED-1DW			x 85 (2 pcs)			x 3.4 (2 pcs)			
PM 352ED-DW			x 195 (2 pcs)			x 7.7 (2 pcs)			
PM 352ED-1DW	950 x 545 x 800	710 x 355	x 195 (1 pcs) 1)	37.4 x 21.5 x 31.5	28.0 x 14.0	x 7.7 (1 pcs) 1)	2	3	11.10
PM 352ED-2DW			x 85 (2 pcs)			x 3.4 (2 pcs)			
			x 85 (4 pcs)			x 3.4 (4 pcs)			
PM 401ED-DW	1060 x 600 x 500	820 x 410	x 195 (1 pcs)	41.7 x 23.6 x 19.7	32.3 x 16.1	x 7.7 (1 pcs)	1	1	6.05
PM 401ED-1DW			x 85 (2 pcs)			x 3.4 (2 pcs)			
PM 402ED-DW			x 195 (2 pcs)			x 7.7 (2 pcs)			
PM 402ED-1DW	1060 x 600 x 800	820 x 410	x 195 (1 pcs) 1)	41.7 x 23.6 x 31.5	32.3 x 16.1	x 7.7 (1 pcs) 1)	2	3	15.10
PM 402ED-2DW			x 85 (2 pcs)			x 3.4 (2 pcs)			
			x 85 (4 pcs)			x 3.4 (4 pcs)			
PM 451ED-DW	1160 x 650 x 500	920 x 460	x 195 (1 pcs)	45.7 x 25.6 x 19.7	36.2 x 18.1	x 7.7 (1 pcs)	1	1	7.21
PM 451ED-1DW			x 85 (2 pcs)			x 3.4 (2 pcs)			
PM 452ED-DW			x 195 (2 pcs)			x 7.7 (2 pcs)			
PM 452ED-1DW	1160 x 650 x 800	920 x 460	x 195 (1 pcs) 1)	45.7 x 25.6 x 31.5	36.2 x 18.1	x 7.7 (1 pcs) 1)	2	3	18.00
PM 452ED-2DW			x 85 (2 pcs)			x 3.4 (2 pcs)			
			x 85 (4 pcs)			x 3.4 (4 pcs)			

1) Model with 1 hearthstone in 1 deck and 2 hearthstone in 1 deck. As standard the ovens delivered with 1 hearthstone in the lower deck and 2 hearthstone in the upper deck. Different configuration can be required



Support Counter Top

Model	Dimensions in mm Width x Depth x Height		Dimensions in inches Width x Depth x Height		Shelf support package
PM 351- S	595 x 598	x 900	23.4 x 23.6	x 35.4	SP-1
PM 352- S		x 750		x 29.5	SP-2
PM 353- S		x 450		x 17.7	-
PM 354- S		x 300		x 11.8	-
PM 401- S	650 x 598	x 900	25.6 x 23.6	x 35.4	SP-1
PM 402- S		x 750		x 29.5	SP-2
PM 403- S		x 450		x 17.7	-
PM 404- S		x 300		x 11.8	-
PM 451- S	700 x 648	x 900	27.6 x 25.5	x 35.4	SP-1
PM 452- S		x 750		x 29.5	SP-2
PM 453- S		x 450		x 17.7	-
PM 454- S		x 300		x 11.8	-
PM 551- S	775 x 723	x 900	30.5 x 28.5	x 35.4	SP-1
PM 552- S		x 750		x 29.5	SP-2
PM 553- S		x 450		x 17.7	-
PM 554- S		x 300		x 11.8	-

Model	Dimensions in mm Width x Depth x Height		Dimensions in inches Width x Depth x Height		Shelf support package
PM 351DW- S	950 x 598	x 900	37.4 x 23.6	x 35.4	SP-1DW
PM 352DW- S		x 750		x 29.5	SP-2DW
PM 353DW- S		x 450		x 17.7	-
PM 354DW- S		x 300		x 11.8	-
PM 401DW- S	1 060 x 598	x 900	41.4 x 23.6	x 35.4	SP-1DW
PM 402DW- S		x 750		x 29.5	SP-2DW
PM 403DW- S		x 450		x 17.7	-
PM 404DW- S		x 300		x 11.8	-
PM 451DW- S	1 160 x 648	x 900	45.7 x 25.5	x 35.4	SP-1DW
PM 452DW- S		x 750		x 29.5	SP-2DW
PM 453DW- S		x 450		x 17.7	-
PM 454DW- S		x 300		x 11.8	-

Important!

For complete oven technical information refer to technical specification sheets for each individual oven series





EU-Declaration of conformity

Svenska BakePartner AB
declare under sole responsibility that the PizzaMaster oven
is approved and in conformity with,

Electromagnetic compatibility Directive **2004/108/EC**,
and applicable supplements

Low voltage Directive **2006/95/EC**, and applicable supplements

PizzaMaster®

Counter Top Ovens

PM 351ED – PM 351ED-1 – PM 352ED – PM 352ED-1 – PM 352ED-2

PM 351ED-DW - PM 351ED-1DW - PM 352ED-DW - PM 352ED-1DW - PM 352ED-2DW

PM 401ED – PM 401ED-1 – PM 402ED – PM 402ED-1 – PM 402ED-2

PM 401ED-DW - PM 401ED-1DW - PM 402ED-DW - PM 402ED-1DW - PM 402ED-2DW

PM 451ED – PM 451ED-1 – PM 452ED – PM 452ED-1 – PM 452ED-2

PM 451ED-DW - PM 451ED-1DW - PM 452ED-DW - PM 452ED-1DW - PM 452ED-2DW

PM 551ED – PM 551ED-1 – PM 552ED – PM 552ED-1 – PM 552ED-2

.....
Christer Andersson
Managing Director
Svenska BakePartner AB
Date
2014-04-01

NEW SOLUTIONS

*We are always ready
to assist you!*

OLD TRADITIONS



PizzaMaster®

PizzaMaster® Stone Hearth Deck Ovens are manufactured by Svenska BakePartner AB

Customer Support: Tel: +46 33 230-025 | Fax: +46 33 248-140 | E-mail: info@bakepartner.com

Website: www.pizzamaster.com or www.bakepartner.com | HQ: Svenska BakePartner AB, Odegardsgatan 5, SE 504 64 Boras Sweden